

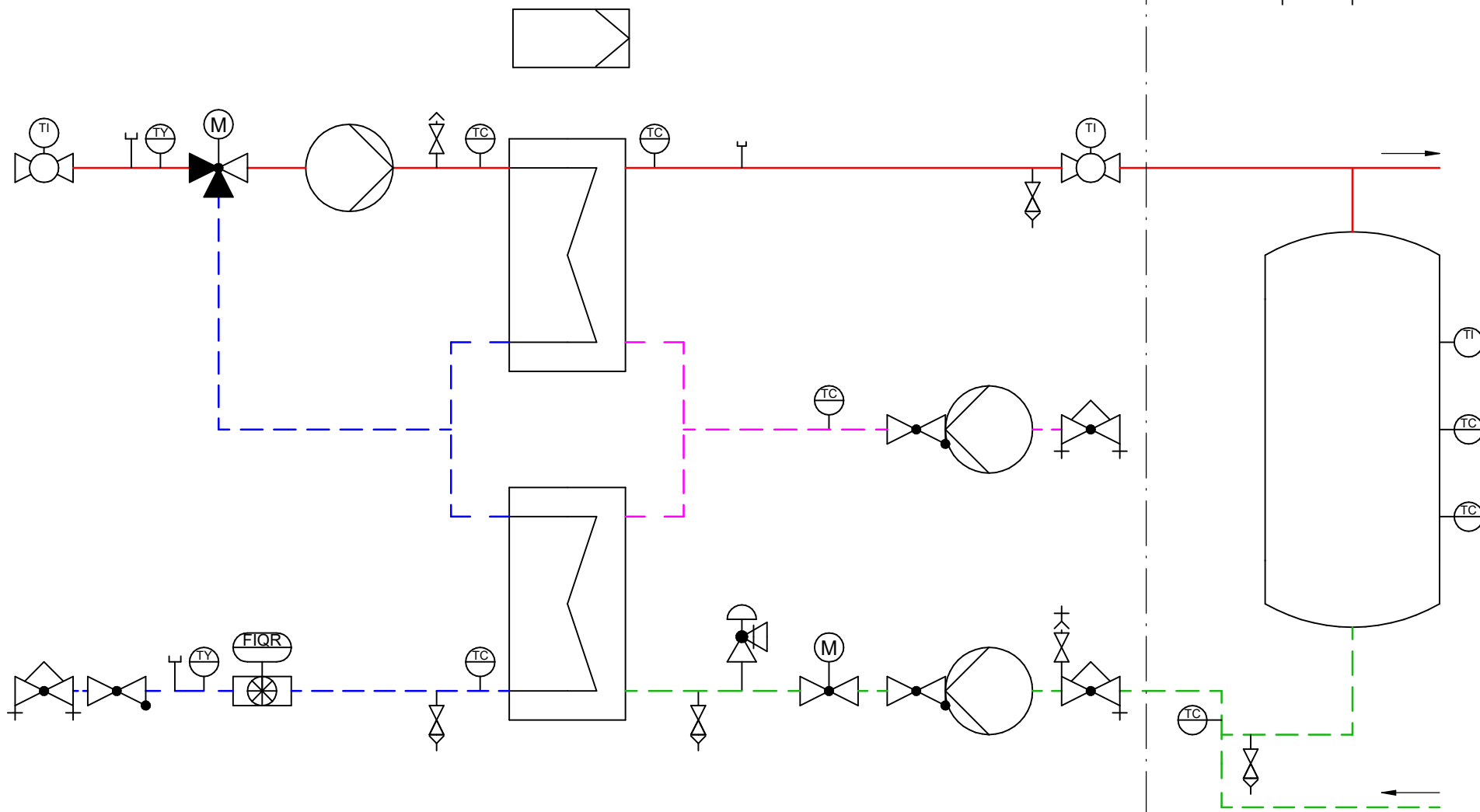





Trinkwassererwärmer TransTherm aqua LS



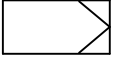
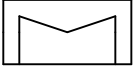



Trinkwarmwasser- pufferspeicher









Dargestellte R&I-Symbole des Fließschemas können auch ein Passstück sein. Welche Bauteile Bestandteil des Produktes bzw. Systems sind, steht in der Stückliste der Leistungsbeschreibung.

		Maßstab :		Material:	
		Masse:		Werkstoff:	
Schutzvermerk nach ISO 16016 beachten Mit der Entgegennahme dieser Zeichnung verpflichtet sich der Empfänger, sie vertraulich zu behandeln. Er darf sie nur zur Ausführung des ihm erteilten Auftrages benutzen, insbesondere also nicht ohne vorherige schriftliche Zustimmung vervielfältigen, Dritten zugänglich machen oder in anderer Weise verwenden. Bei Zuwiderhandlungen haftet uns der Empfänger für alle Schäden.		Name		Datum	
Ersteller		Bednarz, C.		20.11.2015	
Bearb.					
Zeichnungs-Nr.		Material-Nr.		Titel:	
		8006513		TransTherm aqua LS(4-50) Cu-frei 220KW DN32/32 PN10/10 110/80°C TopTronic® E-FW ohne Bedienmodul	
				A3	
				16.11.2018	
				Blatt1/1	

Symbol	Bezeichnung
	DDC - Regler
	Wärmeübertrager
	Temperatursensor
	Wärmezähler
	Temperatursensor für Wärmezähler
	Stutzen Rp (Rohrgewinde innen) mit Stopfen
	Volumenstrombegrenzer mit Messnippel
	Membran Sicherheitsventil

Symbol	Bezeichnung
	Thermometer
	Kugelhahn mit Thermometer
	Entleerung
	Entlüftung
	Pumpe
	Rückschlagventil
	Pufferspeicher

Symbol	Bezeichnung
	Durchgangsventil mit Antrieb ohne Sicherheitsfunktion
	Dreibegeventil (Verteilventil) mit Antrieb ohne Sicherheitsfunktion
	Rücklauf
	Trinkwasser
	Trinkwarmwasser
	Trinkwasser Zirkulation
	Vorlauf