

Legende:

- 1 Kaltwasser/ Cold water
- 2 Warmwasser/ Hotwater
- 3 Vorlauf Heizung/ Flow heating
- 4 Rücklauf Heizung/ Return heating
- 5 Muffe für Thermometer/ Coupling for thermometer
- 6 Anschluss für Einschraub-Elektroheizeinsatz/
sleeve for electric screw-in boiler nozzle
- 7 Zirkulation/ Circulation
- 8 Handloch-Flansch/ Hand-hole flange

- G 1"
- G 1"
- G 1"
- G 1"
- Rp 1/2"
- Rp 1 1/2"
- G 1"
- ø180

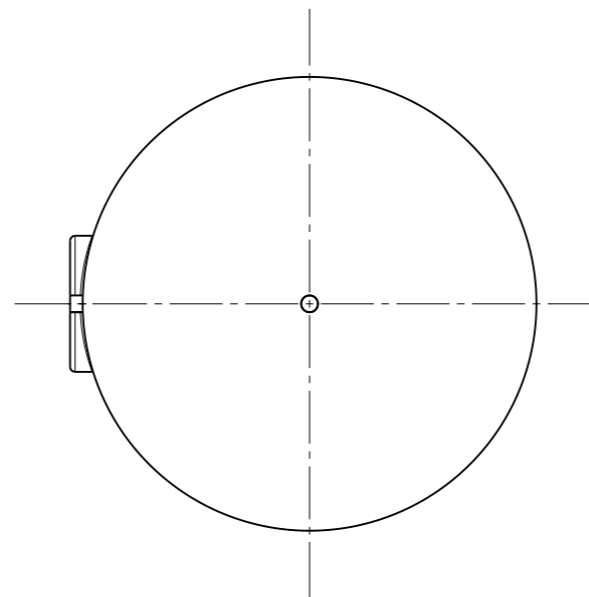

1:15
 Hoval CombiVal CSR (500)
 4215325 Version 00
 Stand: 21.08.2018